

FUEL TANK ASSY COMPONENTS

110TV-02

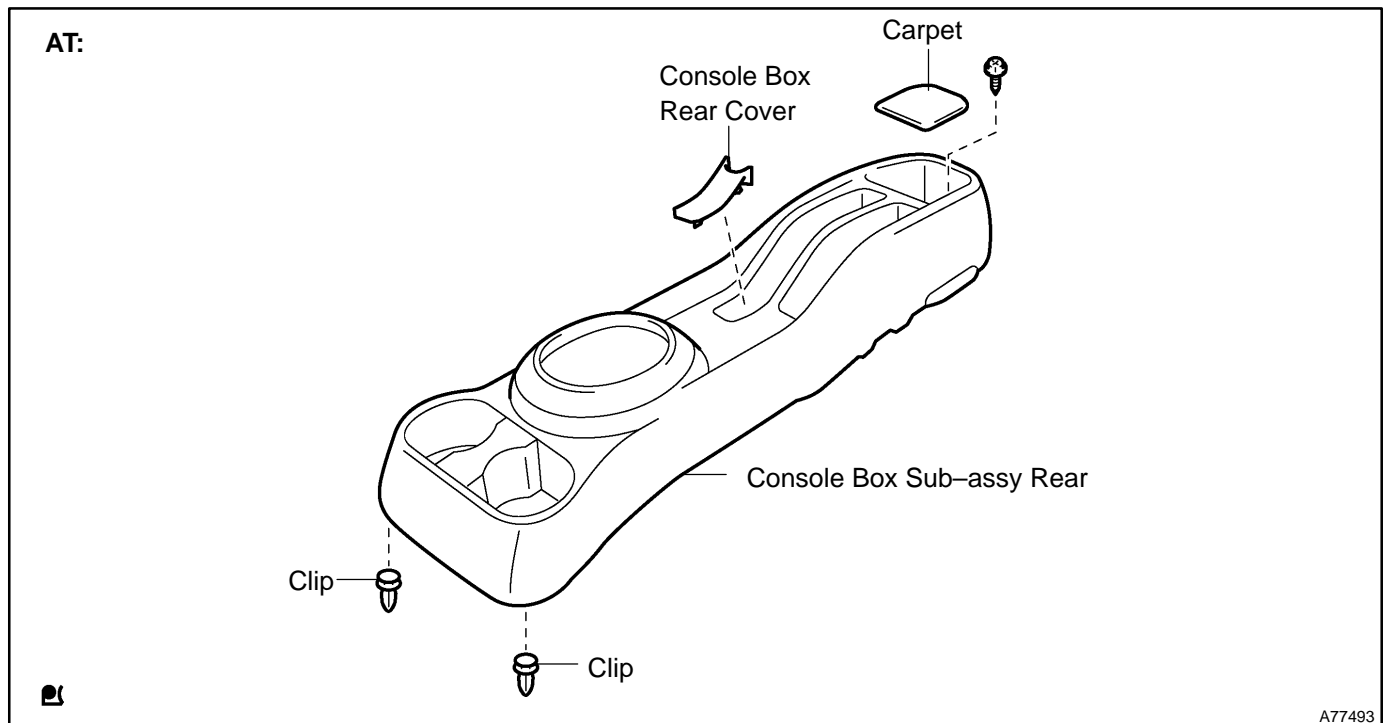

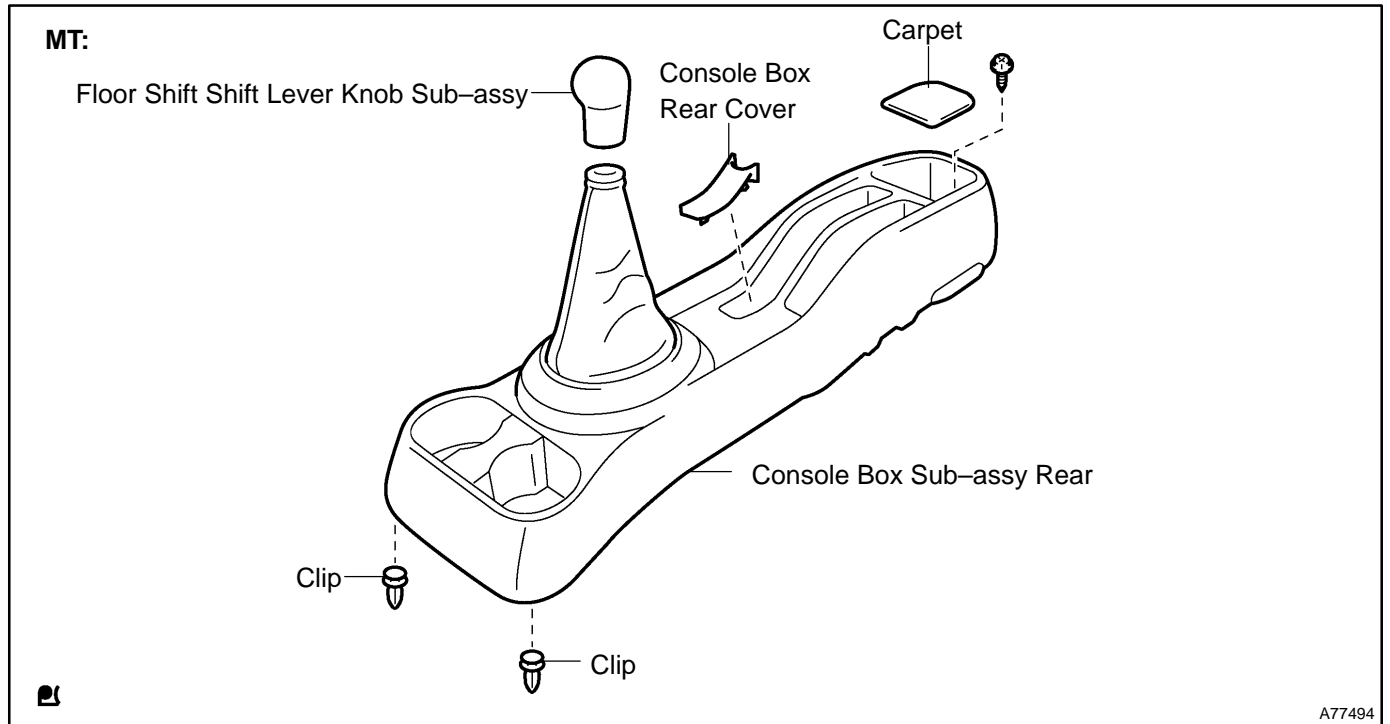
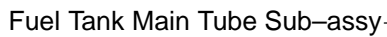
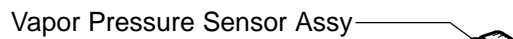
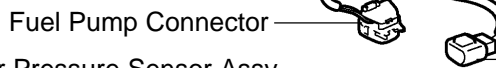
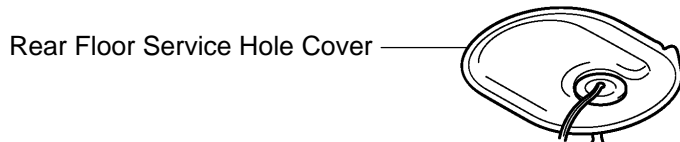
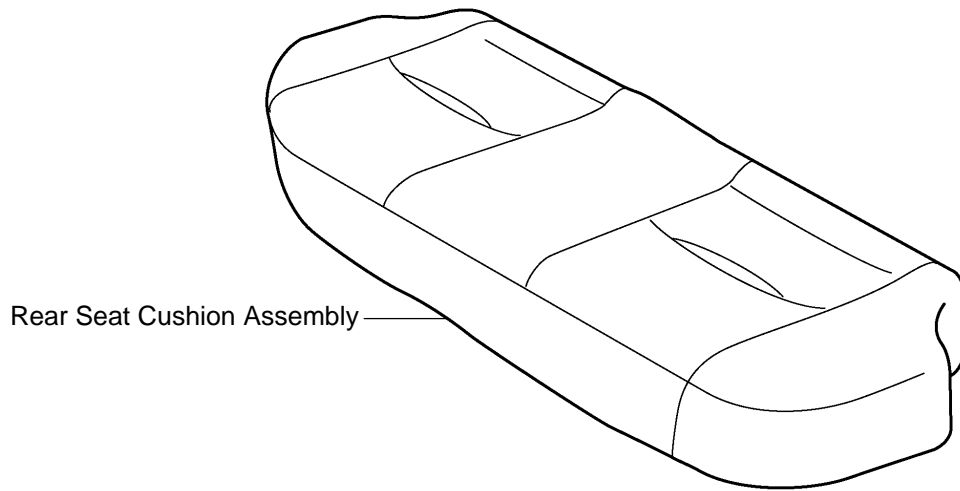

6.0 (61, 53 in.-lbf)

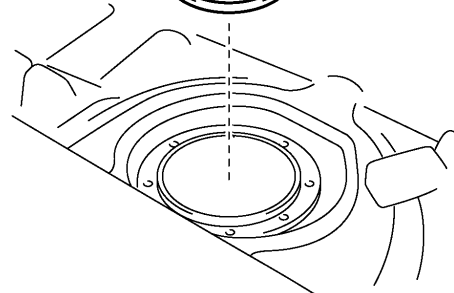
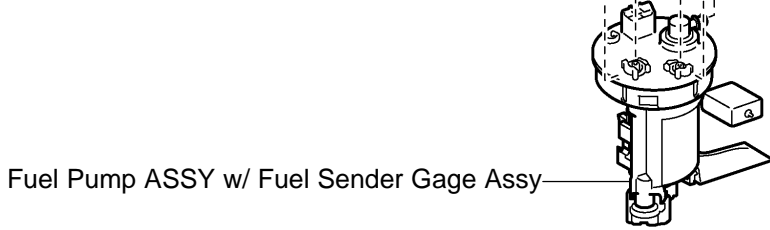
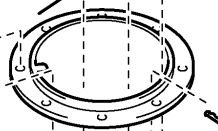
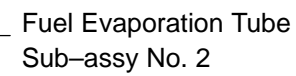
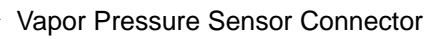

N·m (kgf·cm, ft·lbf) : Specified torque

◆ Non-reusable part

A83434

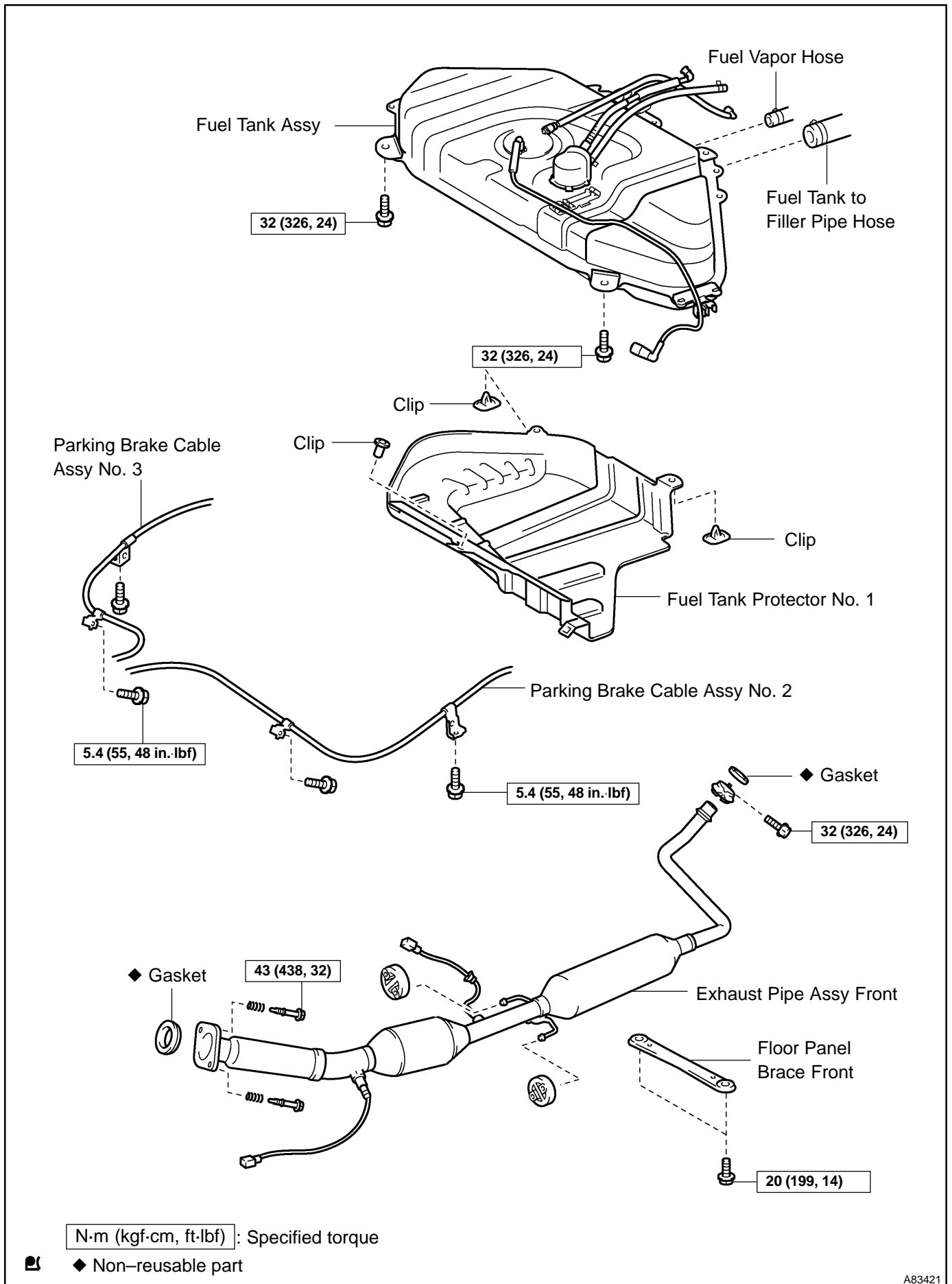

A83421

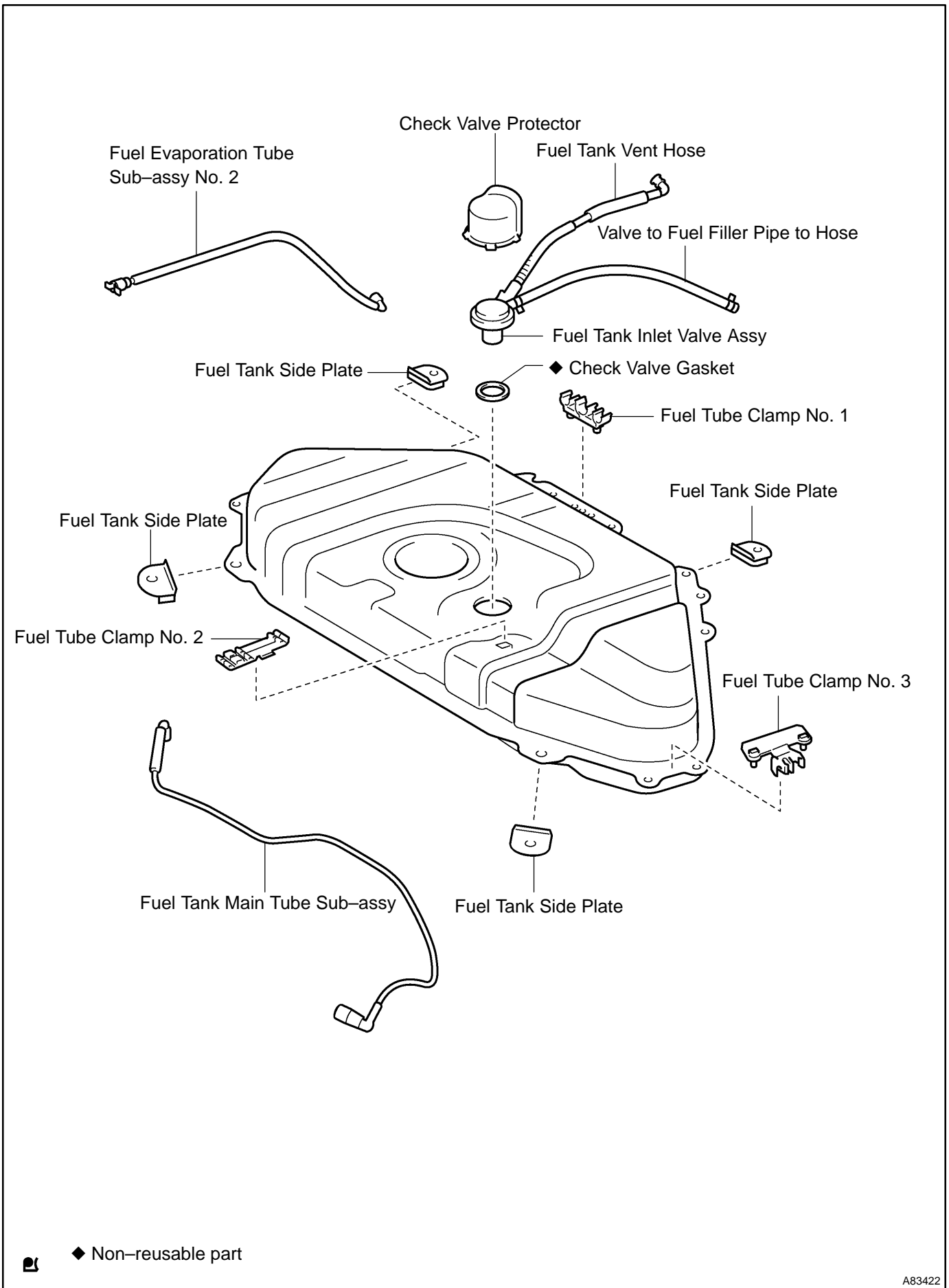

A83422