

DTC	P0171	SYSTEM TOO LEAN (BANK 1)
------------	--------------	---------------------------------

DTC	P0172	SYSTEM TOO RICH (BANK 1)
------------	--------------	---------------------------------

CIRCUIT DESCRIPTION

The fuel trim is related to the feedback compensation value, not to the basic injection time. The fuel trim includes the short-term fuel trim and the long-term fuel trim.

The short-term fuel trim is the short-term fuel compensation used to maintain the air-fuel ratio at stoichiometric air-fuel ratio. The signal from the heated oxygen sensor indicates whether the air-fuel ratio is RICH or LEAN compared to the stoichiometric air-fuel ratio. This variance triggers a reduction in the fuel volume if the air-fuel ratio is RICH, and an increase in the fuel volume if it is LEAN.

The long-term fuel trim is the overall fuel compensation carried out in long-term to compensate for a continual deviation of the short-term fuel trim from the central value, due to individual engine differences, wear over-time and changes in the operating environment.

If both the short-term fuel trim and the long-term fuel trim are LEAN or RICH beyond a certain value, it is detected as a malfunction and the MIL is illuminated.

DTC No.	DTC Detection Condition	Trouble Area
P0171	When air-fuel ratio feedback is stable after warming up engine, fuel trim is considerably in error on LEAN side (2 trip detection logic)	<ul style="list-style-type: none"> • Air induction system • Injector blockage • Mass air flow sensor • Engine coolant temperature sensor • Fuel pressure • Gas leakage in exhaust system • Open or short in heated oxygen sensor (bank 1 sensor 1) circuit • Heated oxygen sensor (bank 1 sensor 1) • Heated oxygen sensor heater (bank 1 sensor 1) • EFI relay • PCV valve and hose • PCV hose connection • ECM
P0172	When air-fuel ratio feedback is stable after warming up engine, fuel trim is considerably in error on RICH side (2 trip detection logic)	<ul style="list-style-type: none"> • Injector leak, blockage • Mass air flow sensor • Engine coolant temperature sensor • Ignition system • Fuel pressure • Gas leakage in exhaust system • Open or short in heated oxygen sensor (bank 1 sensor 1) circuit • Heated oxygen sensor (bank 1 sensor 1) • Heated oxygen sensor heater (bank 1 sensor 1) • EFI relay • ECM

HINT:

- When DTC "P0171" is recorded, the actual air-fuel ratio is on the LEAN side. When DTC "P0172" is recorded, the actual air-fuel ratio is on the RICH side.
- If the vehicle runs out of fuel, the air-fuel ratio is LEAN and DTC "P0171" may be recorded. The MIL then comes on.
- If the total of the short-term fuel trim value and long-term fuel trim value is within $\pm 35\%$ (engine coolant temperature is more than 75°C (167°F)), the system is functioning normally.

MONITOR DESCRIPTION

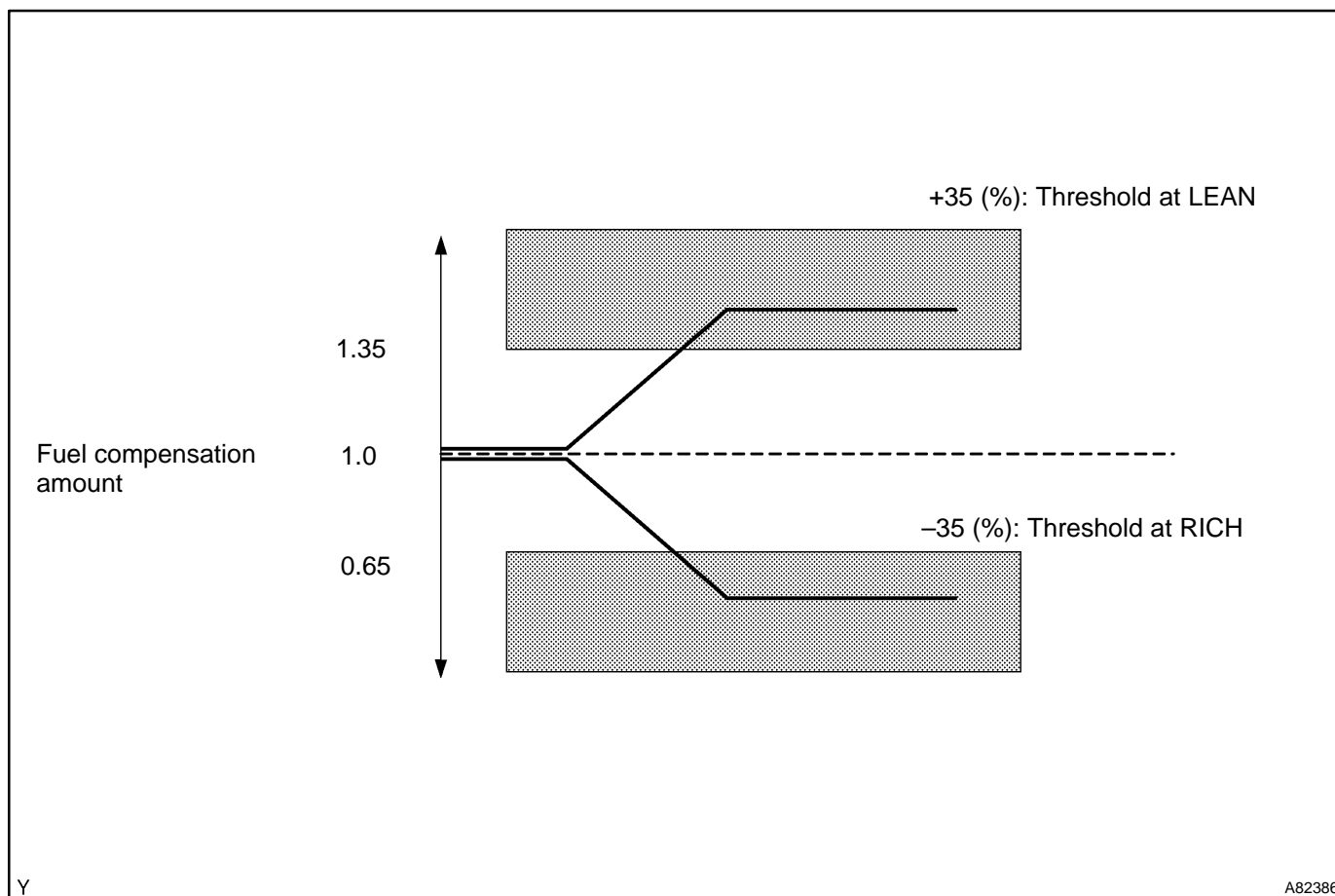

Under closed-loop fuel control, fuel injection amounts that deviate from the ECM's estimated fuel amount will cause a change in the long-term fuel trim compensation value. This long-term fuel trim is adjusted when there are persistent deviations in the short-term fuel trim values. And the deviation from a simulated fuel injection amount by the ECM affects a smoothed fuel trim learning value which is the combination of smoothed short term fuel trim (fuel feedback compensation value) and smoothed long term fuel trim (learning value of the air-fuel ratio). When the smoothed fuel trim learning value exceeds the DTC threshold, the ECM interprets this as a fault in the fuel system and sets a DTC.

Example:

The smoothed fuel trim leaning value is more than +35%, or less than -35%, the ECM interprets this as a fail in the fuel system.

MONITOR STRATEGY

Related DTCs	P0171	Fuel system lean (bank 1)
	P0172	Fuel system rich (bank 1)
Required sensors/components	Main sensors	Front heated oxygen sensor
	Related sensors	Engine coolant temperature sensor, mass air flow sensor, crankshaft position sensor
Frequency of operation	Continuous	
Duration	10 sec	
MIL operation	2 driving cycles	
Sequence of operation	None	

TYPICAL ENABLING CONDITIONS

Item	Specification	
	Minimum	Maximum
The monitor will run whenever the following DTCs are not present	See "List of Disable a Monitor" table (On page 05–24)	
Battery voltage	11 V	–
Fuel system: Closed loop	13 sec	–
One of the following condition is met:	(a) or (b)	
(a) Engine speed	–	1,100 rpm
(b) Intake air amount per revolution	0.15 g/sec or more	–

TYPICAL MALFUNCTION THRESHOLDS

Detection Criteria	Threshold
Either following condition continues for 3 seconds	(a) or (b)
(a) Smoothed fuel trim learning value (lean)	35 % or more
(b) Smoothed fuel trim learning value (rich)	–35 % or less

WIRING DIAGRAM

Refer to DTC P0130 on page 05–96.

INSPECTION PROCEDURE

HINT:

Hand-held tester only:

Narrowing down the trouble area is possible by performing the "A/F CONTROL" ACTIVE TEST (heated oxygen sensor or other trouble areas can be distinguished).

(a) Perform ACTIVE TEST using the hand-held tester (A/F CONTROL).

HINT:

"A/F CONTROL" is ACTIVE TEST which changes the injection volume –12.5 % or +25 %.

- (1) Connect the hand-held tester to the DLC3 on the vehicle.
- (2) Turn the ignition switch ON.
- (3) Warm up the engine by running the engine at 2,500 rpm for approximately 3 minutes.
- (4) Select the item "DIAGNOSIS/ENHANCED OBD II/ACTIVE TEST/ A/F CONTROL".
- (5) Perform "A/F CONTROL" with the engine in an idle condition (press the right or left button).

Result:











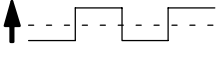

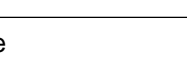
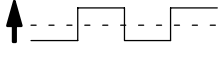
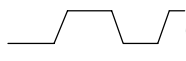
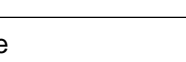
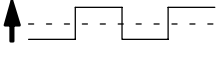
Heated oxygen sensor reacts in accordance with increase and decrease of injection volume:

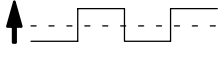
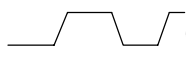
+25 % → rich output: More than 0.5 V

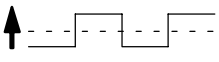
–12.5 % → lean output: Less than 0.4 V

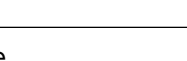
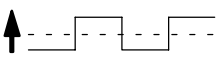
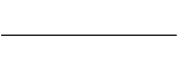
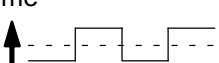
NOTICE:

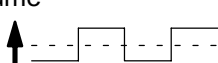
There is a delay of few seconds in the sensor 1 (front sensor) output, and there is about 20 seconds delay at maximum in the sensor 2 (rear sensor).

	Output voltage of heated oxygen sensor (sensor 1: front sensor)	Output voltage of heated oxygen sensor (sensor 2: rear sensor)	Mainly suspect trouble area
Case 1	Injection volume +25 %  -12.5 % Output voltage More than 0.5 V  Less than 0.4V  OK	Injection volume +25 %  -12.5 % Output voltage More than 0.5 V  Less than 0.4V  OK	—
Case 2	Injection volume +25 %  -12.5 % Output voltage No reaction  NG	Injection volume +25 %  -12.5 % Output voltage More than 0.5 V  Less than 0.4V  OK	Sensor 1: front sensor (sensor 1, heater, sensor 1 circuit)
Case 3	Injection volume +25 %  -12.5 % Output voltage More than 0.5 V  Less than 0.4V  OK	Injection volume +25 %  -12.5 % Output voltage No reaction  NG	Sensor 2: rear sensor (sensor 2, heater, sensor 2 circuit)
Case 4	Injection volume +25 %  -12.5 % Output voltage No reaction  NG	Injection volume +25 %  -12.5 % Output voltage No reaction  NG	Extremely rich or lean actual air-fuel ratio (Injector, fuel pressure, gas leakage in exhaust system, etc.)

The following A/F CONTROL procedure enables the technician to check and graph the voltage outputs of both the heated oxygen sensors.

For displaying the graph indication, enter "ACTIVE TEST / A/F CONTROL / USER DATA", then select "O2S B1S1 and O2S B1S2" by pressing "YES" button and push "ENTER" button before pressing "F4" button.

HINT:

- If different DTCs related to different systems that have terminal E2 as the ground terminal are output simultaneously, terminal E2 may be open.
- Read freeze frame data using the hand-held tester or the OBD II scan tool. Freeze frame data records the engine conditions when a malfunction is detected. When troubleshooting, it is useful for determining whether the vehicle was running or stopped, the engine was warmed up or not, the air-fuel ratio was lean or rich, etc. at the time of the malfunction.
- A high heated oxygen sensor (sensor 1) voltage (0.5 V or more) could be caused by a rich air fuel mixture. Check for conditions that would cause the engine to run rich.
- A low heated oxygen sensor (sensor 1) voltage (0.4 V or less) could be caused by a lean air fuel mixture. Check for conditions that would cause the engine to run lean.

1 CHECK AIR INDUCTION SYSTEM

(a) Check the air induction system for vacuum leaks.

NG REPAIR OR REPLACE AIR INDUCTION SYSTEM

OK

2 CHECK CONNECTION OF PCV HOSE

NG REPAIR OR REPLACE PCV HOSE

OK

3 INSPECT FUEL INJECTOR ASSY(INJECTION AND VOLUME) (See page 11-7)

NG REPLACE FUEL INJECTOR ASSY

OK

4 INSPECT MASS AIR FLOW SENSOR

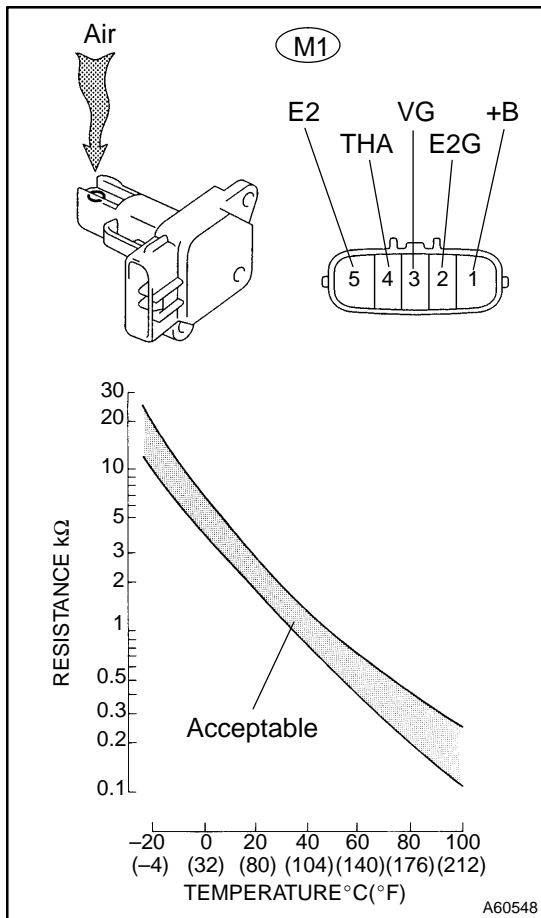

- (a) Remove the mass air flow sensor.
- (b) Output voltage inspection.
 - (1) Apply battery voltage across terminals +B and E2G.
 - (2) Connect the positive (+) tester probe to terminal VG, and negative (-) tester probe to terminal E2G.
 - (3) Blow air into the mass air flow sensor, and check that the voltage fluctuates.
- (c) Resistance inspection.
 - (1) Measure the resistance between terminals of the intake air temperature sensor.

Standard:

Tester Connection	Temperature	Specified Condition
THA (M1-4) - E2 (M1-5)	-20 °C (-4 °F)	13.6 to 18.4 kΩ
	20 °C (68 °F)	2.21 to 2.69 kΩ
	60 °C (140 °F)	0.49 to 0.67 kΩ

(d) Reinstall the mass air flow sensor.

NG REPLACE MASS AIR FLOW SENSOR

OK

5 INSPECT ENGINE COOLANT TEMPERATURE SENSOR(RESISTANCE)

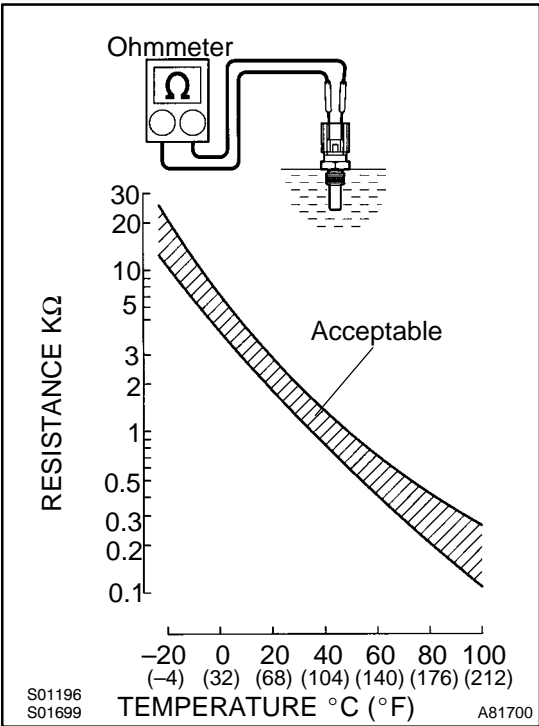

- (a) Remove the engine coolant temperature sensor.
- (b) Measure the resistance between the terminals of the engine coolant temperature sensor.

Resistance:

Tester Connection	Temperature	Specified Condition
1-2	20°C (68°F)	2.32 to 2.59 kΩ
	80°C (176°F)	0.310 to 0.326 kΩ

NOTICE:

In case of checking the engine coolant temperature sensor in water, be careful not to allow water to go into the terminals. After checking, dry the sensor.

HINT:

Alternate procedure: Connect an ohmmeter to the installed engine coolant temperature sensor and read the resistance. Use an infrared thermometer to measure the engine temperature in the immediate vicinity of the sensor. Compare these values to the resistance/temperature graph. Change the engine temperature (warm up or allow to cool down) and repeat the test.

- (c) Reinstall the engine coolant temperature sensor.

NG → **REPLACE ENGINE COOLANT TEMPERATURE SENSOR**

OK

6 CHECK FOR SPARK AND IGNITION (See page 18-1)

NG → **REPAIR OR REPLACE**

OK

7 CHECK FUEL PRESSURE (See page 11-4)

- (a) Check the fuel pressure (high or low pressure).

NG → **CHECK AND REPLACE FUEL SYSTEM**

OK

8 CHECK FOR EXHAUST GAS LEAKAGE

NG → **REPAIR OR REPLACE EXHAUST GAS LEAKAGE POINT (See page 15-3)**

OK

9 READ VALUE OF HAND-HELD TESTER OR OBD II SCAN TOOL(OUTPUT VOLTAGE OF AIR FUEL RATIO SENSOR (BANK 1 SENSOR 1))

- (a) Connect the hand-held tester or the OBD II scan tool to the DLC3.
- (b) Start the engine and push the hand-held tester or the OBD II scan tool main switch ON.
- (c) Select the item "DIAGNOSIS / ENHANCED OBD II / DATA LIST / ALL / O2S B1S1".
- (d) Warm up the heated oxygen sensor with the engine speed at 2,500 rpm for approximately 90 seconds.
- (e) Read the output voltage of the heated oxygen sensor during idling.

Heated oxygen sensor output voltage:

Alternates between less than 0.4 V and more than 0.55 V (See the following table).

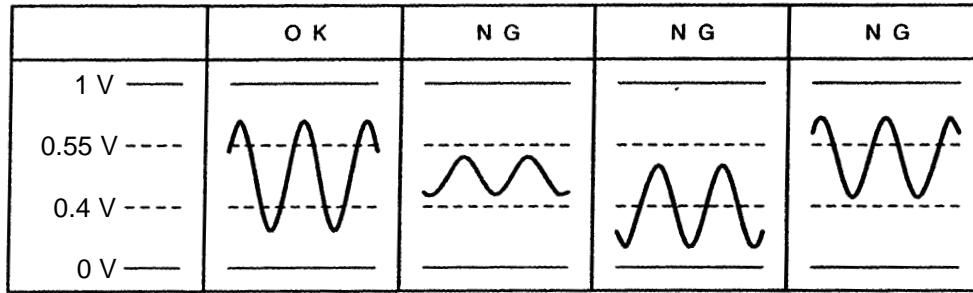

A85277

OK → Go to step 17

NG

10 INSPECT HEATED OXYGEN SENSOR(HEATER RESISTANCE)

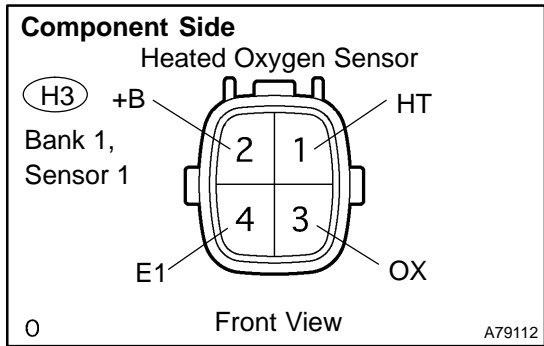

- (a) Disconnect the H3 heated oxygen sensor connector.
- (b) Measure the resistance between the terminals of the heated oxygen sensor connector.

Standard:

Tester Connection	Specified Condition
HT (H3-1) - +B (H3-2)	11 to 16 Ω at 20 °C (68 °F)
HT (H3-1) - E1 (H3-4)	10 kΩ or higher

- (c) Reconnect the heated oxygen sensor connector.

NG → REPLACE HEATED OXYGEN SENSOR

OK

11 INSPECT EFI RELAY

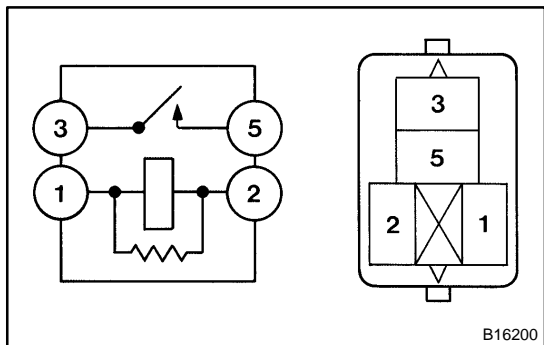

- (a) Remove the EFI relay from the engine room R/B.
- (b) Inspect the EFI relay.

Standard:

Tester Connection	Specified Condition
1 - 2	Continuity
3 - 5	No continuity
	Continuity (Apply battery voltage to terminals 1 and 2)

- (c) Reinstall the EFI relay.

NG → **REPLACE EFI RELAY**

OK

12 CHECK HARNESS AND CONNECTOR(HEATED OXYGEN SENSOR - ECM)

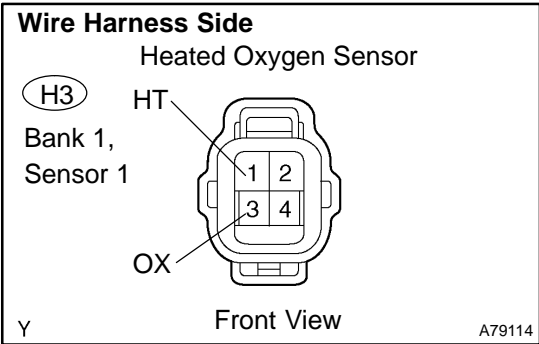

- (a) Disconnect the H3 heated oxygen sensor connector.
- (b) Disconnect the E6 ECM connector.
- (c) Measure the resistance between the wire harness side connectors.

Standard (Check for open):

Tester Connection	Specified Condition
HT (H3-1) - HTL (E6-4)	Below 1 Ω
OX (H3-3) - OXL1 (E6-23)	

Standard (Check for short):

Tester Connection	Specified Condition
HT (H3-1) or HTL (E6-4) - Body ground	10 kΩ or higher
OX (H3-3) or OXL1 (E6-23) - Body ground	

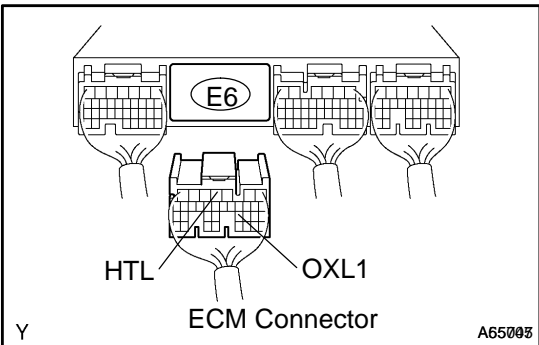

- (d) Reconnect the heated oxygen sensor connector.
- (e) Reconnect the ECM connector.

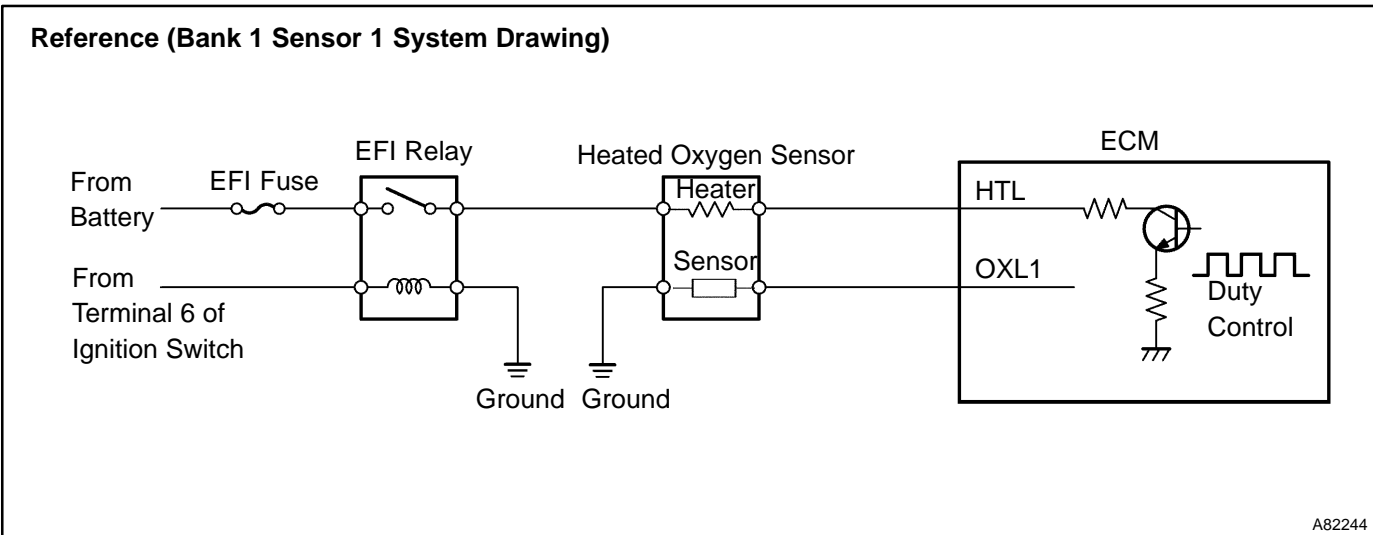

NG → **REPAIR OR REPLACE HARNESS OR CONNECTOR**

OK

13 REPLACE HEATED OXYGEN SENSOR

- (a) Check the air induction system for vacuum leaks.

GO

14 | PERFORM CONFIRMATION DRIVING PATTERN

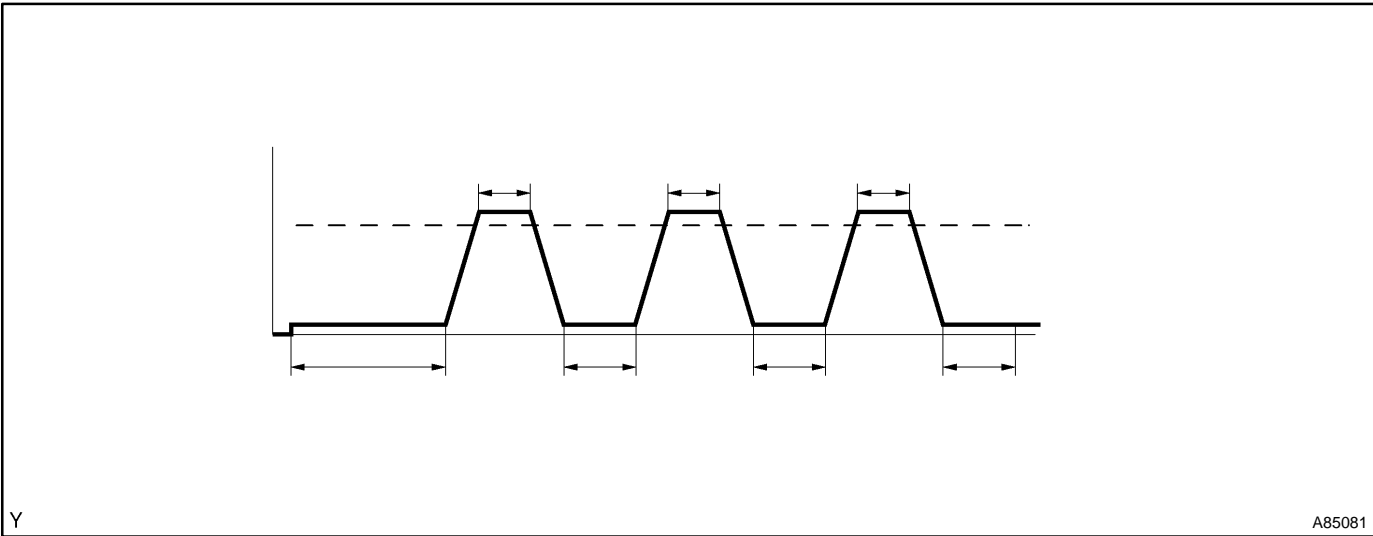

- (a) Connect the hand-held tester to the DLC3.
- (b) Switch the hand-held tester from the "normal mode" to the "check mode" (See page 05-11).
- (c) Start the engine and let the engine idle for 120 seconds or more.
- (d) Drive the vehicle at 40 km/h (25 mph) or more for 40 seconds or more.
- (e) Let the engine idle for 20 seconds or more. Perform steps (d) and (e) at least 3 times.
- (f) Let the engine idle for 30 seconds.

HINT:

If a malfunction exists, the MIL will be illuminated on the multi information display during step (f).

NOTICE:

If the conditions in this test are not strictly followed, detection of a malfunction will not occur. If you do not have a hand-held tester, turn the ignition switch OFF after performing steps from (c) to (f), then perform steps from (c) to (f) again.

GO

15 | READ OUTPUT DTC(DTC P0171 AND/OR P0172 ARE OUTPUT AGAIN)

- (a) Connect the hand-held tester or the OBD II scan tool to the DLC3.
- (b) Turn the ignition switch ON and push the hand-held tester or the OBD II scan tool main switch ON.
- (c) Select the item "DIAGNOSIS / OBD/MOBD / DTC INFO / CURRENT CODES".
- (d) Read the DTC using the hand-held tester or the OBD II scan tool.

Result:

Display (DTC output)	Proceed to
DTC "P0171 and/or P0172" are not output again	A
DTC "P0171 and/or P0172" are output again	B

B → **REPLACE ECM (See page 10-17) AND PERFORM CONFIRMATION DRIVING PATTERN (Refer to step 14)**

A

16 CONFIRM IF VEHICLE HAS RUN OUT OF FUEL IN PAST**NO****CHECK FOR INTERMITTENT PROBLEMS**
(See page 05-41)**YES****DTC IS CAUSED BY RUNNING OUT OF FUEL (DTCS P0171 AND/OR P0172)****17 PERFORM CONFIRMATION DRIVING PATTERN**

HINT:

Clear all DTCs prior to performing the confirmation driving pattern (Refer to step 14).

GO**18 READ OUTPUT DTC(DTC P0171 AND/OR P0172 ARE OUTPUT AGAIN)**

- (a) Connect the hand-held tester or the OBD II scan tool to the DLC3.
- (b) Turn the ignition switch ON and push the hand-held tester or the OBD II scan tool main switch ON.
- (c) Select the item "DIAGNOSIS / OBD/MOBD / DTC INFO / CURRENT CODES".
- (d) Read the DTC using the hand-held tester or the OBD II scan tool.

Result:

Display (DTC output)	Proceed to
DTC "P0171 and/or P0172" are output again	A
DTC "P0171 and/or P0172" are not output again	B

B**Go to step 22****A****19 REPLACE HEATED OXYGEN SENSOR****GO****20 PERFORM CONFIRMATION DRIVING PATTERN**

HINT:

Clear all DTCs prior to performing the confirmation driving pattern (Refer to step 14).

GO

21	READ OUTPUT DTC(DTC P0171 AND/OR P0172 ARE OUTPUT AGAIN)
-----------	---

- (a) Connect the hand-held tester or the OBD II scan tool to the DLC3.
- (b) Turn the ignition switch ON and push the hand-held tester or the OBD II scan tool main switch ON.
- (c) Select the item "DIAGNOSIS / OBD/MOBD / DTC INFO / CURRENT CODES".
- (d) Read the DTC using the hand-held tester or the OBD II scan tool.

Result:

Display (DTC output)	Proceed to
DTC "P0171 and/or P0172" are not output again	A
DTC "P0171 and/or P0172" are output again	B

B	REPLACE ECM (See page 10-17) AND PERFORM CONFIRMATION DRIVING PAT- TERN (Refer to step 14)
----------	---

A

22	CONFIRM IF VEHICLE HAS RUN OUT OF FUEL IN PAST
-----------	---

NO	CHECK FOR INTERMITTENT PROBLEMS (See page 05-41)
-----------	---

YES

DTC IS CAUSED BY RUNNING OUT OF FUEL (DTCS P0171 AND/OR P0172)
